



# Getting Started Guide

BlackBerry 8300 Smartphone

 **BlackBerry**

MAT-15040-001 | PRINTSPEC-016 | RBP41GW



# Contents

<b>Welcome to BlackBerry!</b> .....	<b>3</b>
<b>Set up your device</b> .....	<b>5</b>
Insert the SIM card and battery .....	5
Charge the battery .....	8
Complete the setup wizard .....	10
<b>Learn the basics</b> .....	<b>15</b>
Move around the screen .....	16
Open a menu .....	16
Change the value in a field .....	17
Typing basics .....	18
Applications .....	19
Home screen status indicators .....	20
Message list status indicators .....	21
Phone status indicators .....	22
Wireless network coverage indicators .....	22
<b>Start using your device</b> .....	<b>25</b>
Make a call .....	25
Send an email message .....	25
Send an SMS text message .....	26

Add a contact .....	27
Take a picture .....	27
Visit a web page .....	28
Pair with a Bluetooth enabled device .....	28
About using your device with a computer .....	29
Transfer a file between your device and your computer using the media manager tool .....	31
About accessories .....	31
About adding applications to your device .....	32
Insert a media card .....	32
Find more information .....	34
<b>Troubleshooting .....</b>	<b>35</b>
I cannot connect to a wireless network .....	35
I cannot associate my device with an email address .....	35
I do not know which email setup option to select in the setup wizard .....	36
I cannot send messages .....	37
I am not receiving messages .....	38
I cannot make or receive calls .....	39
<b>Legal notice .....</b>	<b>41</b>

# Welcome to BlackBerry!

Get ready to experience the freedom and connectivity of your all-in-one mobile solution. Setting up your BlackBerry® device is easy. Simply verify that your SIM card and battery are inserted in your device, charge the battery, and complete the setup wizard. After you complete the setup wizard, take some time to explore the features on your device. This guide provides tips and instructions to help you learn the basics quickly.



# Set up your device

## Insert the SIM card and battery

Your SIM card is a small rectangular plastic card that stores important information about your wireless service. Your SIM card might already be inserted in your BlackBerry® device.

1. Press the battery cover release button.
2. Slide off the battery cover.
3. If the battery is inserted, remove the battery.
4. If your SIM card is already inserted, proceed to step 11.
5. Slide the SIM card holder door toward its hinges to unlock it.
6. Open the SIM card holder door.
7. Remove the SIM card from any packaging.
8. Place the SIM card into the holder so that the metal contacts on the SIM card face down and the cutoff corner of the SIM card points toward the top of your device.
9. Close the SIM card holder door so that it holds the SIM card flat.
10. Slide the SIM card holder door away from its hinges to lock it.
11. Insert the battery so that the BlackBerry logo faces up and the metal contacts on the battery align with the metal contacts on your device.

12. Slide the battery cover back onto the device so that it clicks into place. If the battery is charged, the device turns on. If the device does not turn on, charge the battery.

Figure 1. Remove the battery cover

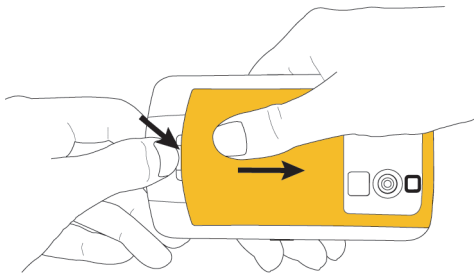



Figure 2. Insert the SIM card

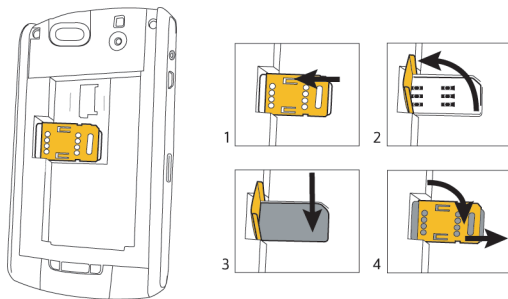
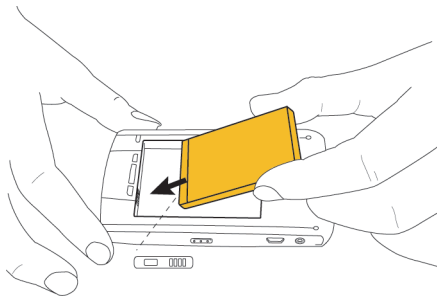

Figure 3. Insert the battery



## Charge the battery

1. If necessary, perform one of the following actions:
  - Insert the plug blade attachment into the power adapter.
  - Fold the plug blades down.
2. Connect the small end of the travel charger cable to the USB port on the side of your BlackBerry® device.
3. Plug the power adapter into a power outlet.
4. Charge the battery to full power.

Figure 4. Insert the plug blade attachment or fold plug blades down (if necessary)

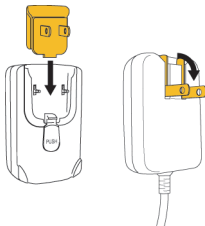
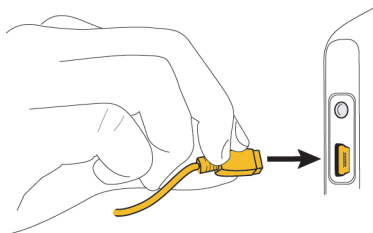





Figure 5. Connect the travel charger cable to your device



If you have an available USB port on your computer and you have installed the BlackBerry® Desktop Software, you can use the USB cable that came with your device to connect your device to your computer for charging. For more information, see the "About using your device with a computer " topic.

## Battery power level indicators

---

	full battery power		battery charging
	low battery power		

---

## Complete the setup wizard

The setup wizard is designed to help you learn about typing, change options to personalize your BlackBerry® device, and set up one or more email addresses. The setup wizard takes approximately 10 minutes to complete.

1. In the setup wizard dialog box, roll the trackball to highlight **Run Setup Wizard**.
2. Click (press) the trackball.
3. Read the setup wizard introduction.
4. Roll the trackball to highlight **Next**.
5. Click the trackball.
6. Complete the instructions on the screen.

**Note:** If the setup wizard dialog box does not appear automatically, on the Home screen, press the  key. Click **Setup Wizard**.

Figure 6. Setup wizard screen

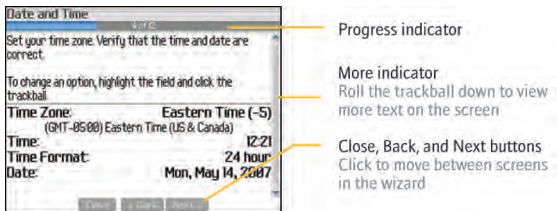

## About email setup options

Use one of the following options to set up email on your BlackBerry® device:

- **BlackBerry Internet Service option:** Use this email setup option to create a new email address for your device or to associate your device with one or more (up to ten) existing email addresses. You can set up email using this option by selecting the **I want to create or add an email address** option in the setup wizard on your device.
- **BlackBerry Enterprise Server option:** Use this email setup option to associate your device with a Microsoft Outlook, IBM Lotus Notes, or Novell® GroupWise® work email account and to take advantage of advanced wireless data synchronization capabilities. If your system administrator has provided you with an enterprise activation password, you can set up email using this option by selecting the **I want to use a work email account with a**

**BlackBerry Enterprise Server** option in the setup wizard on your device. If you do not have an enterprise activation password, contact your system administrator.

- **BlackBerry Desktop Redirector option:** Use this email setup option to associate your device with a Microsoft Outlook (Workgroup Installation) email account. You can set up email using this option by installing the BlackBerry Desktop Software and selecting the BlackBerry Desktop Redirector option. If you use this email setup option, you must keep your computer turned on to receive your email messages.

**Note:** The available email setup options might vary depending on your wireless service plan.

## Add or create an email address using the setup wizard

Depending on your service, the user name that you choose during the email setup might form part of your BlackBerry® email address.

1. In the setup wizard, on the email setup screen, select the **I want to create or add an email address** option. Click **Next**.
2. Click **Next**.
3. If necessary, click **Update Now**.
4. Click **Create New Account**.
5. To accept the terms of the license agreement, select the **I have read and understand the End User Agreement** option or check box. Click **I Accept**.

6. Type a login user name of your choice for the email setup application or the email setup web site.
7. Type a login password of six or more characters. Click **Next**.
8. Record your user name and password in a safe place.
9. Perform one of the following actions:
  - If your service creates a BlackBerry email address for you automatically and you want to change options for the email address, click **View Account** or **Next**.
  - If your service supports multiple email addresses and you want to create a new email address for your BlackBerry device, click **Create a BlackBerry email address** or I would like to create a new BlackBerry email address. Click **Next**.
  - If your service supports multiple email addresses and you want to associate an existing, supported email address with your device, type the email address information. If necessary, click **I would like to use my existing email address** and click **Next** to type the email address information.

To return to the setup wizard, click **Log Out** or **Close**.







# Learn the basics



## Move around the screen

- To move the cursor in any direction and highlight items, roll the trackball.
- To select an item or follow a link, click the trackball.
- To open a menu, press the  key.
- To close a menu or move back a screen, press the  key.

## Open a menu



- To open a list of the applications on your BlackBerry® device, press the  key on the Home screen.
- To open a menu of all the available actions for a highlighted item in an application, press the  key.
- If you click an item with more than one common available action, a short menu of these available actions appears. To view more available actions for the highlighted item, press the  key or click **Full Menu**.

Figure 7. Full menu



Figure 8. Short menu

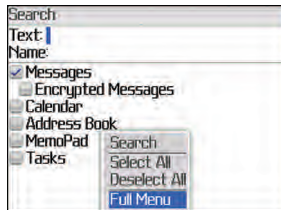

## Change the value in a field

1. Highlight a field.
2. Click the trackball.
3. Click a value.

Figure 9. Change the value in a field

Auto On/Off	
Weekday:	Enabled
Turn On At:	0700
Turn Off At:	2300
<hr/>	
Weekend:	Enabled
Turn On At:	0700
Turn Off At:	2300

## Typing basics

### Typing indicators







---

	Shift mode		number lock mode
	Alt mode		

---

### Typing tips

- To capitalize a letter, hold the letter key until the capitalized letter appears or press a **Shift**  key and the letter key.

- To type the alternate character on a key, hold the  key and the character key.
- To type a symbol, press the  key. Type the letter that appears below the symbol.
- To type an accented or special character, hold the letter key and roll the trackball to the left or right. Release the letter key when the accented or special character appears. For example, to type ü, hold  and roll the trackball to the left until ü appears.
- To turn on NUM lock, press the  key and the **Left Shift**  key.
- To turn off NUM lock, press the  key.

## Applications

Take some time to explore the applications that are available on your BlackBerry® device. Here are a few applications to get you started.



Click **Setup Wizard** to learn about typing, change options to personalize your device, and set up your email address. The setup wizard also provides links to information about common tasks.



Click **Browser** to visit web pages or view the browser bookmark list.

---



Click **Call Log** to make a call or view a list of recent calls.



Click **Camera** to take a picture.



Click **Media** to view saved songs, ring tones, videos, or pictures.



Click **Messages** to view a list of your messages. More than one message list might appear on your device.



Click **Options** to view the main list of device options. You can access additional options from the menu in each application.



Click **Address Book** to view your contact list or add a new contact.



Click **Help** to view the user guide for your device. The user guide provides procedures to help you use your device.

## Home screen status indicators



alarm set









missed call count











unopened  
message count



sending data

	missed calendar reminder		receiving data
	voice mail message		roaming
	Bluetooth® technology is turned on		paired with Bluetooth enabled device

## Message list status indicators

	unopened message		MMS message
	opened message		sent message
	message with an attachment		message is sending
	message is high priority		message not sent
	SMS text message		

## Phone status indicators



missed call



received call



placed call

---

## Wireless network coverage indicators

Indicators on the Home screen display the wireless coverage level for the area in which you are using your BlackBerry® device. A wireless coverage level might limit the use of some device features.

---

### **EDGE**

You can use the phone, send and receive email, PIN, SMS text, and MMS messages, and use the browser with a high-speed data connection.

---

### **GPRS**

You can use the phone, send and receive email, PIN, SMS text, and MMS messages, and use the browser.

---

### **edge**

You can use the phone and send and receive SMS text messages.

### **gprs**



## GSM

---



You can only make emergency calls.

---



Your connection to the mobile network is turned off.

---



You are not in a wireless coverage area.

---



# Start using your device

## Make a call

1. On the Home screen or in the phone, perform one of the following actions:
  - Type a phone number.
  - Type part of a contact name. Highlight a contact or phone number.
2. Press the  key.

To end the call, press the  key.

## Send an email message

1. In a message list, press the  key.
2. Click **Compose Email**.
3. In the **To** field, perform one of the following actions:
  - Type an email address.
  - Type a contact name.
  - Type part of a contact name. Click a contact.
4. Type a message.

5. Click the trackball.
6. Click **Send**.

**Note:** If your BlackBerry® device is associated with more than one email address, in the Send Using field, you can set the email address that you want to use to send the email message.

## Send an SMS text message

1. In a message list, press the  key.
2. Click **Compose SMS**.
3. Perform one of the following actions:
  - If the contact is not in your address book, click **[Use Once]**. Type an SMS phone number (include the country code and area code) or an email address. Click the trackball.
  - If the contact is in your address book, click a contact.
4. Type a message.
5. Click the trackball.
6. Click **Send**.

## Add a contact





1. In the address book, press the  key.
2. Click **New Address**.
3. Type the contact information.
4. Click the trackball.
5. Click **Save**.

## Take a picture

By default, when you take a picture, the camera saves the picture to the BlackBerry® device memory.

1. In the camera, click the trackball.
2. Perform one of the following actions:
  - To take another picture, click the **camera** icon.
  - To delete the picture, click the **trash can** icon.
  - To set the picture as a caller ID picture or Home screen background, click the **crop** icon.
  - To forward the picture, click the **envelope** icon.
  - To rename and save the picture, click the **folder** icon.

## Visit a web page

1. In the browser, press the  key.
2. Click **Go To**.
3. Perform one of the following actions:
  - Type a web address. Press the  key.
  - Highlight a web address. Press the  key.
  - Highlight a web address. Press the  key. Click **Edit**. Change the web address. Press the  key.
4. Click **OK**.

## Pair with a Bluetooth enabled device

Some Bluetooth® enabled devices have passkeys that you must type before you can pair with them.

1. In the Bluetooth setup application, click **OK**.
2. Click a Bluetooth enabled device.
3. If required, type the passkey for the Bluetooth enabled device on your BlackBerry® device.

4. If required, type the passkey for the Bluetooth enabled device on the Bluetooth enabled device.

## About using your device with a computer

You can install the BlackBerry® Desktop Software on your computer and connect your BlackBerry device to your computer to perform any of the following actions:

- Synchronize organizer data such as contacts, calendar entries, tasks, and memos between your device and your computer.
- Back up and restore device data.
- Transfer files between your device and your computer.
- Add applications to your device.
- Set up and manage email message forwarding or wireless calendar synchronization if your system administrator has advised you to do so.
- Set up and manage email message forwarding using the BlackBerry Desktop Redirector to forward email messages from a Microsoft® Outlook® (Workgroup installation) email account that resides on a Microsoft Exchange Server version 5.5 or later.

For more information about synchronizing data, backing up or restoring data, adding applications, or other functions, see the *BlackBerry Desktop Software Online Help*.

## Installation prerequisites

- Intel® compatible 486 or higher computer that is compliant with USB 1.1 or later
- Microsoft® Windows® 2000, or later
- available USB port
- CD drive

## Install the BlackBerry Desktop Software

1. Verify that your BlackBerry® device is not connected to your computer.
2. Insert the BlackBerry User Tools CD into the CD drive on your computer.
3. Click **BlackBerry Desktop Software**.
4. Complete the instructions on the screen.
5. When the installation is complete, connect the smaller end of the USB cable to the USB port on the side of your device.
6. Connect the larger end of the USB cable to the USB port on your computer.

**Note:** If the BlackBerry Desktop Manager does not open automatically, on the taskbar, click **Start > Programs > BlackBerry > Desktop Manager**.



## Transfer a file between your device and your computer using the media manager tool

1. Connect your BlackBerry® device to your computer.
2. On your computer, open the BlackBerry® Desktop Manager.
3. Double-click **Media Manager**.
4. Drag a file or folder from one location to another.

For more information about using the media manager tool, see the *Media Manager Online Help*.

## About accessories

You can buy accessories such as batteries, carrying solutions, headsets, and charging solutions for your BlackBerry® device. Contact your wireless service provider or visit [www.shopblackberry.com](http://www.shopblackberry.com) for more information.

**CAUTION:** Use only accessories that Research In Motion has approved for use with your device model. Use of other accessories might invalidate your warranty and might be dangerous.

## About adding applications to your device

You can download applications for your BlackBerry® device from a web site such as [mobile.blackberry.com](http://mobile.blackberry.com) using the browser on your device. You can also download application files from a web site such as [www.handango.com/blackberry/](http://www.handango.com/blackberry/) using a browser on your computer. If you download applications using a browser on your computer, you can add the application to your device using the application loader tool of the BlackBerry Desktop Software. The BlackBerry Desktop Software is available on the *BlackBerry User Tools CD* that came with your device.

**CAUTION:** If you add an application to your device, read the terms and conditions for the application carefully. Research In Motion makes no representation, warranty, or guarantee whatsoever for applications that you add to your device and assumes no liability for them.

## Insert a media card

Use a microSD media card to extend the memory available on your BlackBerry® device for storing media files such as songs, ring tones, videos, or pictures. The media card might be sold separately from your device.

1. Press the battery cover release button.
2. Slide off the battery cover.
3. Slide the media card holder door toward its hinges to unlock it.
4. Open the media card holder door.

5. Place the media card into the slots in the media card holder door so that the metal contacts on the media card align with the metal contacts on your device when the media card holder door is closed.
6. Close the media card holder door.
7. Slide the media card holder door away from its hinges to lock it.
8. Slide the battery cover back onto the device so that it clicks into place.

Figure 10. Insert the media card

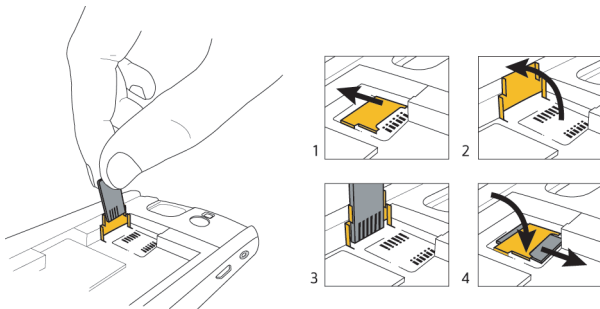

## Find more information

- To view the user guide for your BlackBerry® device, click **Help** in the application list or in an application menu.
- To view the BlackBerry 101 tutorial, user guide, safety and product information booklet, or software license agreement and warranty for your device, insert the *BlackBerry User Tools CD* that came with your device into the CD drive on your computer.
- To try a free 30-minute introductory training course (available in English only) for your device or to purchase additional training, visit [www.blackberry.com/go/onlinetraining](http://www.blackberry.com/go/onlinetraining).
- To find information about your wireless network or your wireless service plan, visit your wireless service provider web site.
- To find software, games, and accessories for your device, visit [www.discoverblackberry.com](http://www.discoverblackberry.com).

# Troubleshooting

## I cannot connect to a wireless network

Try performing the following actions:

- Verify that your SIM card is inserted in your BlackBerry® device correctly.
- Verify that you have turned on the connection to the wireless network.
- Verify that you are connected to your wireless service provider's network. If you switched wireless networks manually, your device remains connected to that wireless network until you select your wireless service provider's network again.

## I cannot associate my device with an email address

Try performing the following actions:

- On the email setup screen, verify that you have typed all the email address information correctly.
- Log in to the email setup web site using a browser on your computer and add an email address to your BlackBerry® device. To log in to the email setup web site, type the email setup web site address provided by your wireless service provider in a browser on your computer. If you have already created a login

user name and password, use this information to log in. If you have not created a login user name and password, click **Create New Account** and complete the instructions on the screen. To associate your device with a Microsoft® Outlook® or IBM® Lotus Notes® work email account, you must visit the BlackBerry® Internet Service email setup web site using a browser on your computer.

- Verify that the email address is associated with a supported email account (for example, a POP3 or IMAP email account). For more information about supported email accounts, contact your wireless service provider.

## I do not know which email setup option to select in the setup wizard



- Select the **I want to create or add an email address** option if the other options do not apply to you. This option is the most common option for individual users. If you select this option, an email setup application or email setup web site opens on your BlackBerry® device. In the email setup application or on the email setup web site, you can create a new email address for your device or associate your device with an existing, supported email address.
- Select the **I want to use a work email account with a BlackBerry Enterprise Server** option if a system administrator has provided you with a password that you can use to activate your device over the wireless network. If you select this option, an Enterprise Activation screen appears. On this screen, you can

type your work email address and the password provided by your system administrator to activate your device.

- Select the **I want to skip email setup** option if any of the following situations apply:
  - A representative from the store where you purchased your device has already helped you to set up your email address.
  - You have already visited the email setup web site and have set up an email address using a browser on your computer.
  - You have an existing email account and have access to a BlackBerry® Enterprise Server, but your system administrator has not provided you with a password that you can use to activate your device over the wireless network. For more information about setting up email for your device, contact your system administrator.
  - You have a Microsoft® Outlook® (Workgroup installation) email account on a Microsoft® Exchange Server Version 5.5. or later and you want to use the BlackBerry® Desktop Redirector to forward email messages to your device.

## I cannot send messages

Try performing the following actions:

- Verify that your BlackBerry® device is connected to the wireless network. If you are not in a wireless coverage area, your device should send the messages when you return to a wireless coverage area.
- If the menu item for sending a message does not appear, verify that you have added an email address or PIN for your contact.
- If you created an email address or added an existing email address to your device using the email setup web site, verify that you have received an activation message on your device from the BlackBerry Internet Service. If you have not received an activation message (the message might take a short period of time to arrive), use the email setup web site to send a service book to your device.
- If you have not received a registration message from the wireless network, register your device. In the device options, click **Advanced Options**. Click **Host Routing Table**. Press the  key. Click **Register Now**.
- Resend the message. Open the message. Press the  key. Click **Resend**.

## I am not receiving messages

Try performing the following actions:

- Verify that your BlackBerry® device is connected to the wireless network. If you are not in a wireless coverage area, you should receive messages when you return to a wireless coverage area.



- If you created an email address or added an existing email address to your device using the email setup web site, verify that you have received an activation message on your device from the BlackBerry Internet Service. If you have not received an activation message (the message might take a short period of time to arrive), use the email setup web site to send a service book to your device.
- If you have not received a registration message from the wireless network, register your device. In the device options, click **Advanced Options**. Click **Host Routing Table**. Press the  key. Click **Register Now**.
- If you switched devices, verify that you have updated the device PIN on the email setup web site. To find your device PIN, in the device options, click **Status**. Log in to the email setup web site. Click **Change Device**. Type the new BlackBerry device information. Click **Save**.
- If you use email message filters, verify that the options for email message filters are set correctly.

## I cannot make or receive calls

Try performing the following actions:

- Verify that your BlackBerry® device is connected to the wireless network.
- If you cannot make calls and fixed dialing is turned on, verify that the phone number for your contact appears in your fixed dialing list or turn off fixed dialing.

- If you have traveled to another country and you have not changed your smart-dialing options, dial the full phone number, including the country code and area code, for your contact.
- If you are not receiving calls, verify that call blocking and call forwarding are turned off.
- If your SIM card supports more than one phone number, but you have only one phone number, verify that the phone number is set as the primary number.

## Legal notice

©2007 Research In Motion Limited. All Rights Reserved. The BlackBerry and RIM families of related marks, images, and symbols are the exclusive properties of Research In Motion Limited. RIM, Research In Motion, BlackBerry, "Always On, Always Connected" and the "envelope in motion" symbol are registered with the U.S. Patent and Trademark Office and may be pending or registered in other countries.

The Bluetooth word mark and logos are owned by the Bluetooth SIG, Inc. and any use of such marks by Research In Motion is under license. Handango is a trademark of Handango, Inc. IBM, Lotus, Domino, and Lotus Notes are trademarks of IBM Corporation. Intel is a trademark of Intel Corporation. Microsoft, Outlook, and Windows are trademarks of Microsoft Corporation. Novell and GroupWise are trademarks of Novell, Inc. All other brands, product names, company names, trademarks, and service marks are the properties of their respective owners.

The BlackBerry device and/or associated software are protected by copyright, international treaties, and various patents, including one or more of the following U.S. patents: 6,278,442; 6,271,605; 6,219,694; 6,075,470; 6,073,318; D445,428; D433,460; D416,256. Other patents are registered or pending in various countries around the world. Visit [www.rim.com/patents](http://www.rim.com/patents) for a list of RIM (as hereinafter defined) patents.

This document is provided "as is" and Research In Motion Limited and its affiliated companies ("RIM") assume no responsibility for any typographical, technical, or other inaccuracies in this document. In order to protect RIM proprietary and confidential

information and/or trade secrets, this document may describe some aspects of RIM technology in generalized terms. RIM reserves the right to periodically change information that is contained in this document; however, RIM makes no commitment to provide any such changes, updates, enhancements, or other additions to this document to you in a timely manner or at all. RIM MAKES NO REPRESENTATIONS, WARRANTIES, CONDITIONS, OR COVENANTS, EITHER EXPRESS OR IMPLIED (INCLUDING WITHOUT LIMITATION, ANY EXPRESS OR IMPLIED WARRANTIES OR CONDITIONS OF FITNESS FOR A PARTICULAR PURPOSE, NON-INFRINGEMENT, MERCHANTABILITY, DURABILITY, TITLE, OR RELATED TO THE PERFORMANCE OR NON-PERFORMANCE OF ANY SOFTWARE REFERENCED HEREIN OR PERFORMANCE OF ANY SERVICES REFERENCED HEREIN). IN CONNECTION WITH YOUR USE OF THIS DOCUMENTATION, NEITHER RIM NOR ITS RESPECTIVE DIRECTORS, OFFICERS, EMPLOYEES, OR CONSULTANTS SHALL BE LIABLE TO YOU FOR ANY DAMAGES WHATSOEVER BE THEY DIRECT, ECONOMIC, COMMERCIAL, SPECIAL, CONSEQUENTIAL, INCIDENTAL, EXEMPLARY, OR INDIRECT DAMAGES, EVEN IF RIM HAS BEEN ADVISED OF THE POSSIBILITY OF SUCH DAMAGES, INCLUDING WITHOUT LIMITATION, LOSS OF BUSINESS REVENUE OR EARNINGS, LOST DATA, DAMAGES CAUSED BY DELAYS, LOST PROFITS, OR A FAILURE TO REALIZE EXPECTED SAVINGS.

This document might contain references to third-party sources of information, hardware or software, products or services and/or third-party web sites (collectively the "Third-Party Information"). RIM does not control, and is not responsible for, any Third-Party Information, including, without limitation the content, accuracy, copyright compliance, compatibility, performance, trustworthiness, legality, decency, links, or any other aspect of Third-Party Information. The inclusion of Third-Party

Information in this document does not imply endorsement by RIM of the Third-Party Information or the third party in any way. Installation and use of Third-Party Information with RIM's products and services may require one or more patent, trademark, or copyright licenses in order to avoid infringement of the intellectual property rights of others. Any dealings with Third-Party Information, including, without limitation, compliance with applicable licenses and terms and conditions, are solely between you and the third party. You are solely responsible for determining whether such third-party licenses are required and are responsible for acquiring any such licenses relating to Third-Party Information. To the extent that such intellectual property licenses may be required, RIM expressly recommends that you do not install or use Third-Party Information until all such applicable licenses have been acquired by you or on your behalf. Your use of Third-Party Information shall be governed by and subject to you agreeing to the terms of the Third-Party Information licenses. Any Third-Party Information that is provided with RIM's products and services is provided "as is". RIM makes no representation, warranty or guarantee whatsoever in relation to the Third-Party Information and RIM assumes no liability whatsoever in relation to the Third-Party Information even if RIM has been advised of the possibility of such damages or can anticipate such damages.

Research In Motion Limited

295 Phillip Street

Waterloo, ON N2L 3W8

Canada

Research In Motion UK Limited

200 Bath Road

Slough, Berkshire SL1 3XE

United Kingdom

Published in Canada